

Fixing Blocks

Application:

To mount panels to profiles with a t-slot width of 8mm. An M6 screw is required for installation.

SZ1512S for 2 mm panels.

SZ1514S for 4 mm panels.

SZ1516S for 6 mm panels.

SZ1518S for 8 mm panels.

SZ1510S facilitate the entire 2 - 8 mm range of panels.

Acc.:

SZ1510S fixing block 40 Vario is a complete set. It includes four different sized, removable caps to accommodate panels with 2 - 8 mm thickness.

Material: PA, black

System: 40



SZ1510S

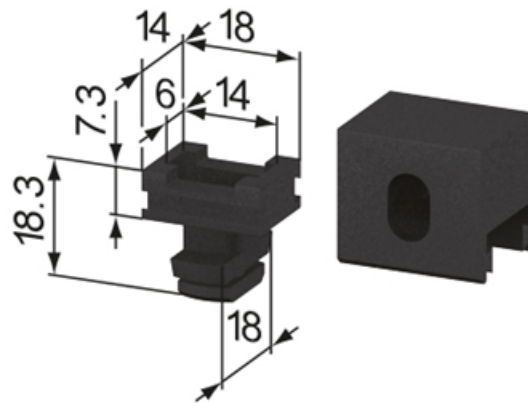

Insert for SZ1510S

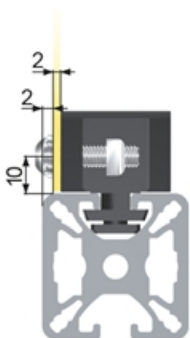

SZ1512S

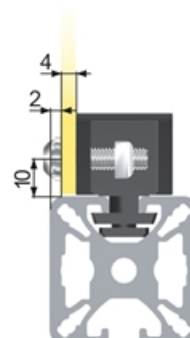
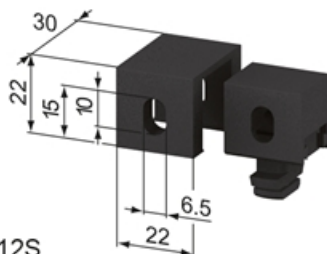

SZ1514S

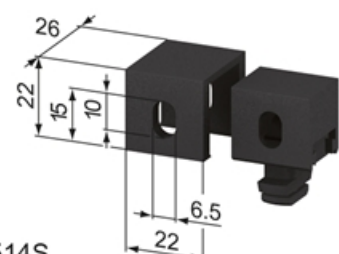

Fixing Blocks

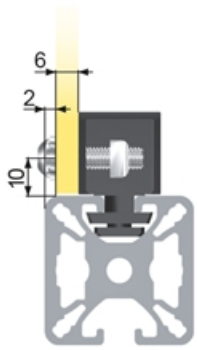

SZ1516S

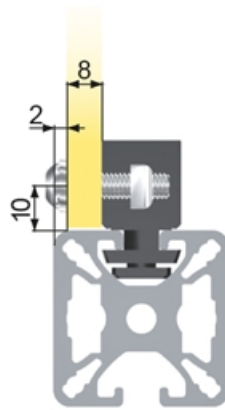
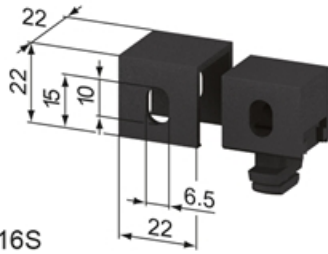

SZ1518S

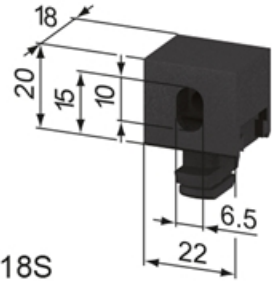

Variant Data

Designation	Description	Weight (g)	Compatible with
SZ1510S	Fixing Block 40 vario	27	2-8 mm panels
SZ1512S	Fixing Block 40 / 2	19	2 mm panels
SZ1514S	Fixing Block 40 / 4	16	4 mm panels
SZ1516S	Fixing Block 40 / 6	14	6 mm panels
SZ1518S	Fixing Block 40 / 8	10	8 mm panels